



DVD/VIDEO CD/CD PLAYER

DVD-S510

OWNER'S MANUAL





This symbol warns the user that uninsulated voltage within the unit may have sufficient magnitude to cause electric shock. Therefore, it is dangerous to make any kind of contact with any inside part of this unit.



This symbol alerts the user that important literature concerning the operation and maintenance of this unit has been included. Therefore, it should be read carefully in order to avoid any problems.

WARNING

To reduce the risk of fire or electric shock, do not expose this appliance to rain or moisture.

CAUTION

Use of controls or adjustments or performance of procedures other than herein may result in hazardous radiation exposure.

The set complies with the FCC-Rules, Part 15 and with 21 CFR 1040.10.

Canada

This digital apparatus does not exceed the Class B limits for radio noise emissions from digital apparatus as set out in the Radio Interference Regulations of the Canadian Department of Communications.

IMPORTANT SAFETY INSTRUCTIONS

Read before operating equipment

This product was designed and manufactured to meet strict quality and safety standards. There are, however, some installation and operation precautions which you should be particularly aware of.

1. **Read these instructions** – All the safety and operating instructions should be read before the appliance is operated.
2. **Keep these instructions** – The safety and operating instructions should be retained for future reference.
3. **Heed all warnings** – All warnings on the appliance and in the operating instructions should be adhered to.
4. **Follow all instructions** – All operating and use instructions should be followed.
5. **Do not use this apparatus near water** – for example, near a bathtub, washbowl, kitchen sink, laundry tub, in a wet basement or near a swimming pool, etc.
6. **Clean only with a damp cloth.** The appliance should be cleaned only as recommended by the manufacturer.
7. **Install in accordance with the manufacturer's instructions. Do not block any of the ventilation openings.** For example, the appliance should not be situated on a bed, sofa, rug, or similar surface or placed in a built-in installation, such as a bookcase or cabinet that may impede the flow of air through the ventilation openings.
8. **Do not install near any heat sources** such as radiators, heat registers, stoves, or other apparatus (including amplifiers) that produce heat.

9. Do not defeat the

safety purpose of the polarized or grounding-type plug. A polarized plug has two blades with one wider than the other. A grounding type plug has two blades and a third grounding prong. The wide blade or the third prong are provided for your safety. When the provided plug does not fit into your outlet, consult an electrician for replacement of the obsolete outlet.

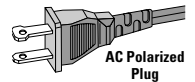

10. **Protect the power cord** from being walked on or pinched particularly at plugs, convenience receptacles, and the point where they exit from the apparatus.
11. **Only use attachments/accessories** specified by the manufacturer.
12.  **Use only with a cart,** stand, tripod, bracket, or table specified by the manufacturer, or sold with the apparatus. When a cart is used, use caution when moving the cart/apparatus combination to avoid injury from tip-over.
13. **Unplug this apparatus** during lightning storms or when unused for long periods of time.
14. **Refer all servicing** to qualified service personnel. Servicing is required when the apparatus has been damaged in any way, such as power-supply cord or plug is damaged, liquid has been spilled or objects have fallen into the apparatus, the apparatus has been exposed to rain or moisture, does not operate normally, or has been dropped.

EL 4562-E004: 99/3

FCC INFORMATION (for US customers only)

1. IMPORTANT NOTICE: DO NOT MODIFY THIS UNIT!

This product, when installed as indicated in the instructions contained in this manual, meets FCC requirements. Modifications not expressly approved by Yamaha may void your authority, granted by the FCC, to use the product.

2. IMPORTANT: When connecting this product to accessories and/or another product use only high quality shielded cables. Cable/s supplied with this product **MUST** be used. Follow all installation instructions. Failure to follow instructions could void your FCC authorization to use this product in the USA.

3. NOTE: This product has been tested and found to comply with the requirements listed in FCC Regulations, Part 15 for Class "B" digital devices. Compliance with these requirements provides a reasonable level of assurance that your use of this product in a residential environment will not result in harmful interference with other electronic devices. This equipment generates/uses radio frequencies and, if not installed and used according to the instructions found in the users manual, may cause interference harmful to the operation of other electronic devices. Compliance with FCC regulations does not guarantee that interference will not occur in all installations. If this product is found to be the source of interference, which can be determined by turning the product "OFF" and "ON", please try to eliminate the problem by using one of the following measures: Relocate either this product or the device that is being affected by the interference.

Utilize power outlets that are on different branch (circuit breaker or fuse) circuits or install AC line filter/s.

In the case of radio or TV interference, relocate/reorient the antenna. If the antenna lead-in is 300 ohm ribbon lead, change the lead-in to coaxial type cable.

If these corrective measures do not produce satisfactory results, please contact the local retailer authorized to distribute this type of product. If you can not locate the appropriate retailer, please contact Yamaha Electronics Corp., 6600 Orangethorpe Ave. Buena Park, CA90622.

The above statements apply **ONLY** to those products distributed by Yamaha Corporation of America or its subsidiaries.

We Want You Listening For A Lifetime

YAMAHA and the Electronic Industries Association's Consumer Electronics Group want you to get the most out of your equipment by playing it at a safe level. One that lets the sound come through loud and clear without annoying blaring or distortion - and, most importantly, without affecting your sensitive hearing.

Since hearing damage from loud sounds is often undetectable until it is too late, YAMAHA and the Electronic Industries Association's Consumer Electronics Group recommend you to avoid prolonged exposure from excessive volume levels.



LASER SAFETY

This unit employs a laser. Due to possible eye injury, only a qualified service person should remove the cover or attempt to service this device.

USE OF CONTROLS OR ADJUSTMENTS OR PERFORMANCE OF PROCEDURES OTHER THAN THOSE SPECIFIED HEREIN MAY RESULT IN HAZARDOUS RADIATION EXPOSURE.

CAUTION

VISIBLE AND INVISIBLE LASER RADIATION WHEN OPEN AVOID EXPOSURE TO BEAM (WARNING LOCATION: INSIDE ON LASER COVERSHEILD OR THE BACKPLATE OF SET)

LASER	
Type	Semiconductor laser GaAlAs
Wave length	650 nm (DVD) 780 nm (VCD/CD)
Output Power	7 mW (DVD) 10 mW (VCD/CD)
Beam divergence	60 degree

DANGER - Visible and invisible laser radiation when open. Avoid exposure to beam.

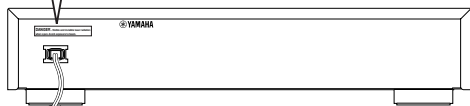

NOTE:
PICTURES SHOWN MAYBE DIFFERENT BETWEEN COUNTRIES.

NEVER MAKE OR CHANGE CONNECTIONS WITH THE POWER SWITCHED ON.

When playing DTS encoded CDs, excessive noise will be heard from the analog stereo outputs. To avoid possible damage to the audio system, the consumer should take proper precautions when the analog stereo outputs of the DVD player are connected to an amplification system. To enjoy DTS Digital Surround™ playback, an external 5.1-channel DTS Digital Surround™ decoder system must be connected to the digital output of the DVD player.

For Customer Use:

Read carefully the information located at the bottom of your DVD-VIDEO player and enter below the Serial No. Retain this information for future reference.

Model No.

Serial No. _____

Contents

The region code for this set is 1.

Since it is usual for DVD movies to be released at different times in different regions of the world, all players have region codes and discs can have an optional region code. If you load a disc of a different region code to your player, you will see the region code notice on the screen. The disc will not play and should be unloaded.



TruSurround and the SRS symbol are trademarks of SRS Labs., Inc. TruSurround technology is incorporated under license from SRS Labs., Inc.

TruSurround™
by **SRS** (●)®

Manufactured under license from Dolby Laboratories. "Dolby" and the double-D symbol are trademarks of Dolby Laboratories. Confidential Unpublished Works. ©1992-1997 Dolby Laboratories, Inc. All rights reserved.

This product incorporates copyright protection technology that is protected by method claims of certain U.S. patents and other intellectual property rights owned by Macrovision Corporation and other rights owners. Use of this copyright protection technology must be authorized by Macrovision Corporation, and is intended for home and other limited viewing uses only unless otherwise authorized by Macrovision Corporation. Reverse engineering or disassembly is prohibited.

Introduction	6
Entertainment for the new millennium	6
Introduction	6
Unpacking	7
Caution	7

Functional overview	8
Front panel	8
Rear panel	9
Display	10
Remote control	11

On screen display information	12
Temporary Feedback Field icons	13

Preparation	14
General notes	14
Digital Connections	14
Analog Connections	15
Video Connections	15
Connecting the power cord	16
Remote control battery installation	16
NTSC/PAL Settings	16
General explanation	17
Turning On the power	18
Initial Setup	18
Personal Preferences	19
Access control; child lock (DVD and VCD)	21
Access control; Parental control (DVD-Video only)	22

Operation	24
Loading discs	24
Playing a DVD-video disc	24
Playing a Video CD	25
General features	25
Special DVD features	29
Special VCD-Features	30
Playing an audio CD	30
FTS (Favorite Track Selection) Program	32

Before requesting service	33
Cleaning discs	34

Specifications	35
-----------------------------	-----------

Introduction

Entertainment for the new millennium

Video was never like this before! Digital video discs provide perfect digital, studio-quality pictures; three dimensional digital, multi-channel audio; story sequences screened from your choice of camera angle; sound tracks in as many as eight languages; and up to 32 subtitles (if available on disc). Whether you watch DVD-Video on wide-screen or regular TV, you always see it the way it was meant to be.

Digital video

DVD-Video uses state-of-the-art MPEG2 data compression technology to register an entire movie on a single 5-inch disc. DVD's variable bitrate compression, running at up to 9.8 Mbits/second, captures even the most complex pictures in their original quality.

The crystal-clear digital pictures have a horizontal resolution of over 500 lines, with 720 pixels (picture elements) to each line. This resolution is more than double that of VHS, superior to Laser Disc, and entirely comparable with digital masters made in recording studios.

DVD-Video discs conform to either the PAL or NTSC video standard. This player can play both PAL and NTSC discs, presenting them in the best possible way on your multi-standard TV screen.

As the universal video system of the future, DVD-Video offers optimal pictures on any TV screen.

Introduction

Your DVD-Video player will play digital video discs conforming to the universal DVD-Video standard. With it, you will be able to enjoy full-length movies with true cinema picture quality, as well as stereo or multi-channel sound (depending on the disc and your playback setup). The unique features of DVD-Video, such as selection of sound track, subtitle languages and different camera angles (again depending on the disc), are all included. What's more, Child Lock lets you decide which discs your children will be able to see.

In addition to DVD-Video discs, you will be able to play all Video CDs and Audio CDs (including finalized CD Recordable and CD Rewritable).

You will find the On-Screen Display, player display, and remote control make the player easy to use. This manual provides all the information you will need, so read on!

DVD-Video

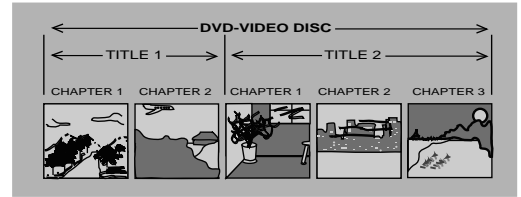

You will recognize DVD-Video discs by the logo shown on left. Depending on the material on the disc (a movie, video clips, a drama series, etc.) the disc may have one or more Titles. Each Title may have one or more Chapters. To make playback easy and convenient, your player lets you select Titles and playback Chapters.

Video CD



You will recognize Video CDs by the logo shown at left. Depending on the material on the disc (a movie, video clips, a drama series, etc.) the disc may have one or more tracks. Tracks may have one or more indexes, as indicated on the disc case. To make playback easy and convenient, your player lets you select tracks and indexes.

SuperVCD

SVCD discs based on the SuperVCD IO Standard based on the Standard of the Electronics Industry of the People's Republic of China.

Audio CD



Audio CDs contain music tracks only.

You will recognize Audio CDs by their logo which is shown at left.

You can play them in conventional style through a stereo system, using the keys on the remote control and/or front panel, or via the TV using the On-Screen Display (OSD).

Unpacking

First check and identify the contents of your DVD-Video player package.

You should have the following items.

- DVD-Video player
- Remote Control with batteries
- AC power cord
- Audio/Video cable
- Owner's manual

If any item is damaged or missing, contact your retailer.

Keep the packaging materials; you may need them to transport your player in the future.

Caution

- 1 To assure the finest performance, please read this manual carefully. Keep it in a safe place for future reference.
- 2 Install this unit in a well ventilated, cool, dry, and clean place with at least 2.5 cm above, behind and on the both sides of this unit - away from direct sunlight, heat sources, vibration, dust, moisture, and/or cold.
- 3 Position this unit away from other electrical appliances, motors and transformers to avoid humming sounds, do not place this unit where it may get exposed to rain or any kind of liquid to prevent fire or electrical shock.
- 4 Avoid extreme temperature swings or excessive use of humidifier in the room where this unit is installed to prevent condensation inside this unit, which may cause an electrical shock, fire, damage to this unit, and/or personal injury.
- 5 Do not cover this unit with a newspaper, a tablecloth, a curtain, etc. in order not to obstruct heat radiation. If the temperature inside this unit rises, it may cause fire, damage to this unit and/or personal injury.
- 6 Avoid installing this unit in a place where foreign objects and liquid might fall. It might cause a fire, damage to this unit and/or personal injury. Do not place the following objects on this unit:
 - Other components, as they may cause damage and/or discoloration on the surface of this unit.
 - Burning objects (i.e., candles), as they may cause fire, damage to this unit and/or personal injury.
 - Containers with liquid in them, as they may cause an electrical shock to the user and/or damage to this unit.
- 7 Do not operate this unit upside-down. It may overheat, possibly causing damage.
- 8 Do not use force on switches, controls or connection cables. Never pull the cables when disconnecting them.
- 9 Only voltage specified on this unit must be used. Using this unit with a higher voltage than specified is dangerous and may result in fire or other accidents. YAMAHA will not be held responsible for any damage resulting from the use of this unit with a voltage other than that specified.

- 10 Do not attempt to clean this unit with chemical solvents; this might damage the finish. Use a clean, dry cloth.
- 11 Disconnect the power cord from the wall outlet when not planning to use this unit for a long period of time, or during an electrical storm, as they may cause damage by lightning.
- 12 Do not attempt to modify or fix this unit. Contact the qualified YAMAHA service personnel when any service is needed. Cabinet should never be opened for any reasons.
- 13 Be sure to read 'Before requesting service' section regarding common operating errors before concluding that this unit is faulty.
- 14 When moving this unit, be sure to first disconnect the power cord from the AC outlet and disconnect all cords connecting this unit to other equipment.

Functional overview

Front panel

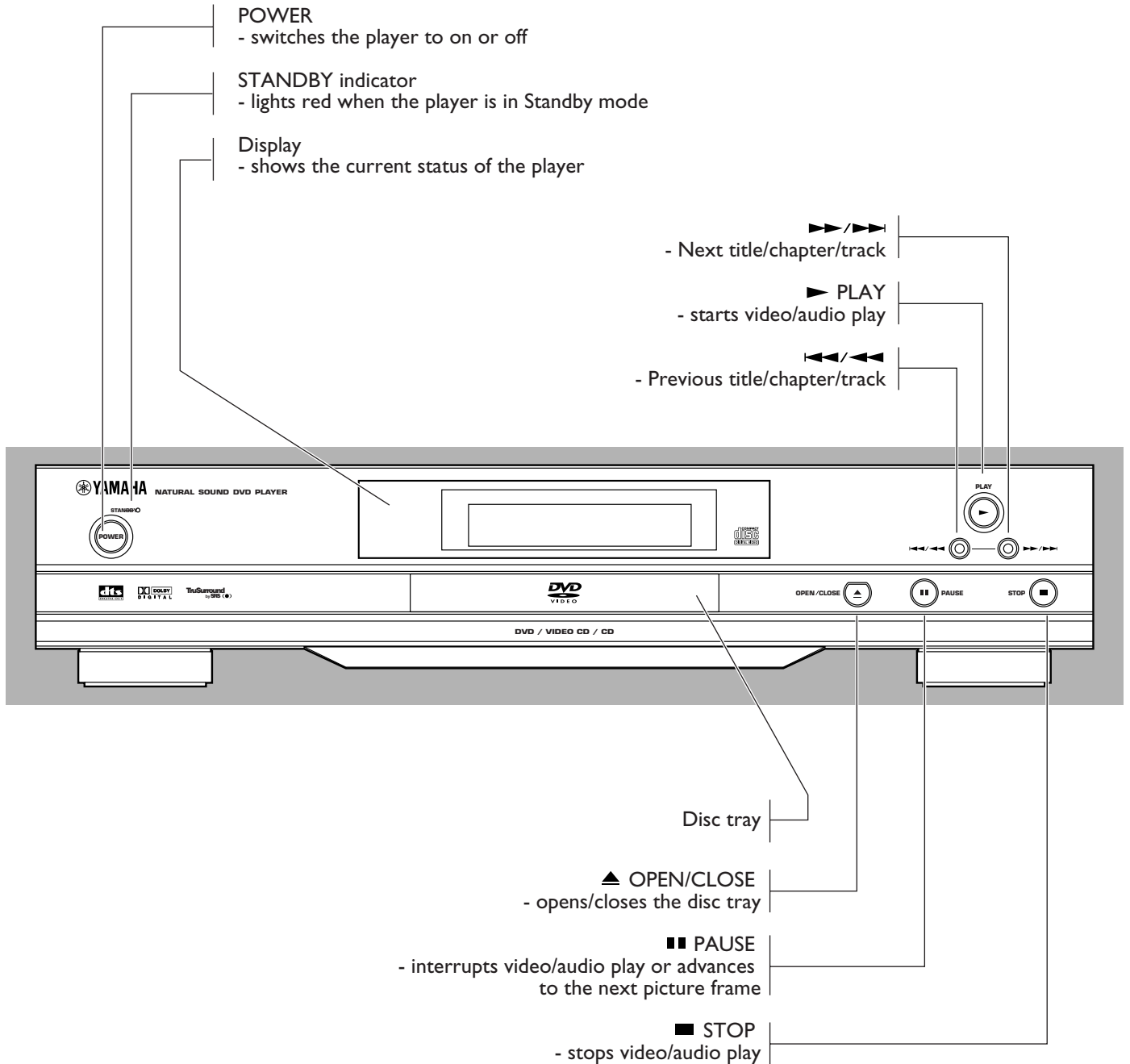

Rear panel

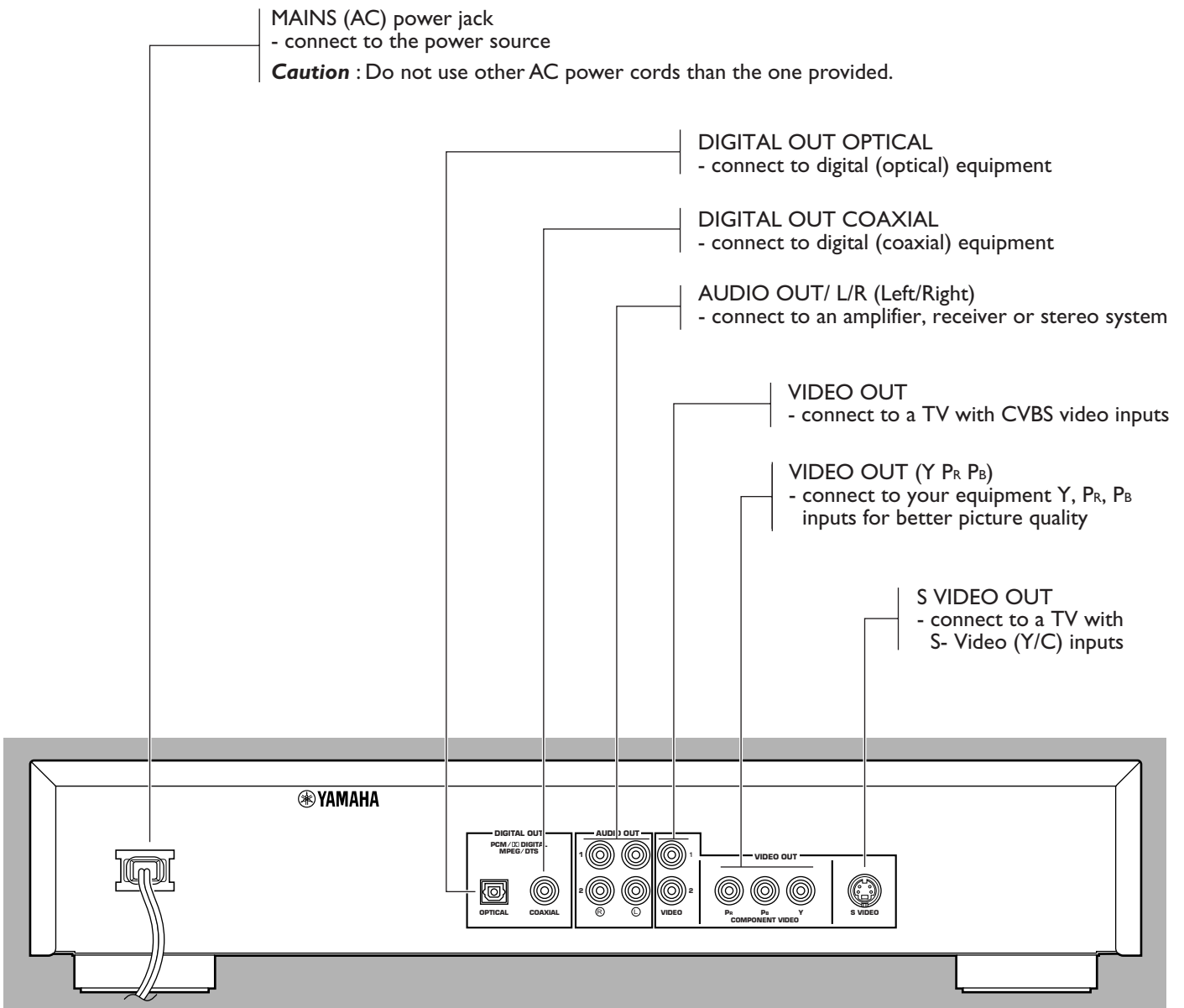

Caution: Do not touch the inner pins of the jacks on the rear panel connectors. Electrostatic discharge may cause permanent damage to the unit.

Display

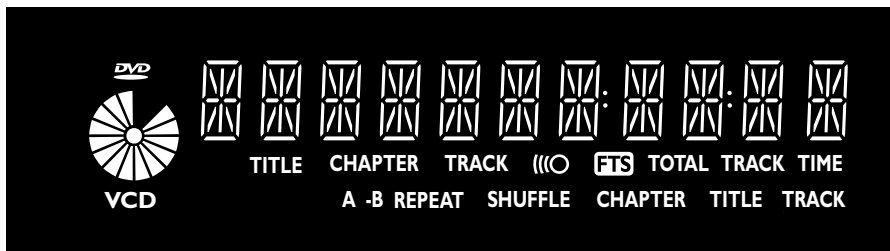
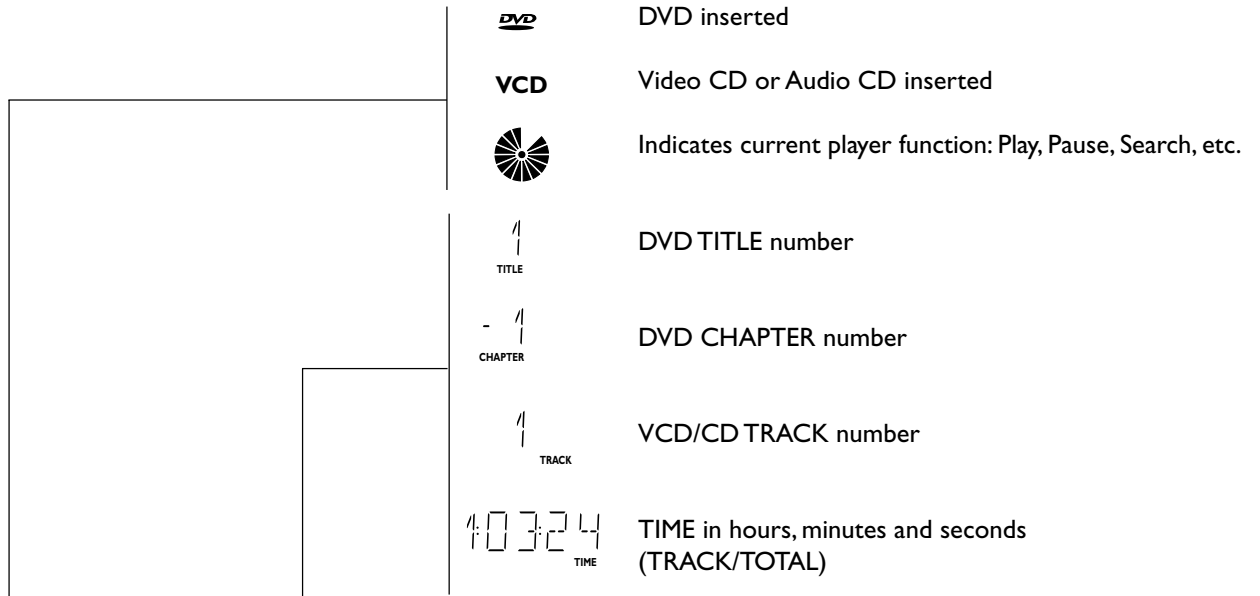

REPEAT CHAPTER/TITLE/TRACK active

(((O Remote control active (flashing)

FTS FTS active

A-B REPEAT A-B active

REPEAT REPEAT active

SHUFFLE SHUFFLE active

Remote control

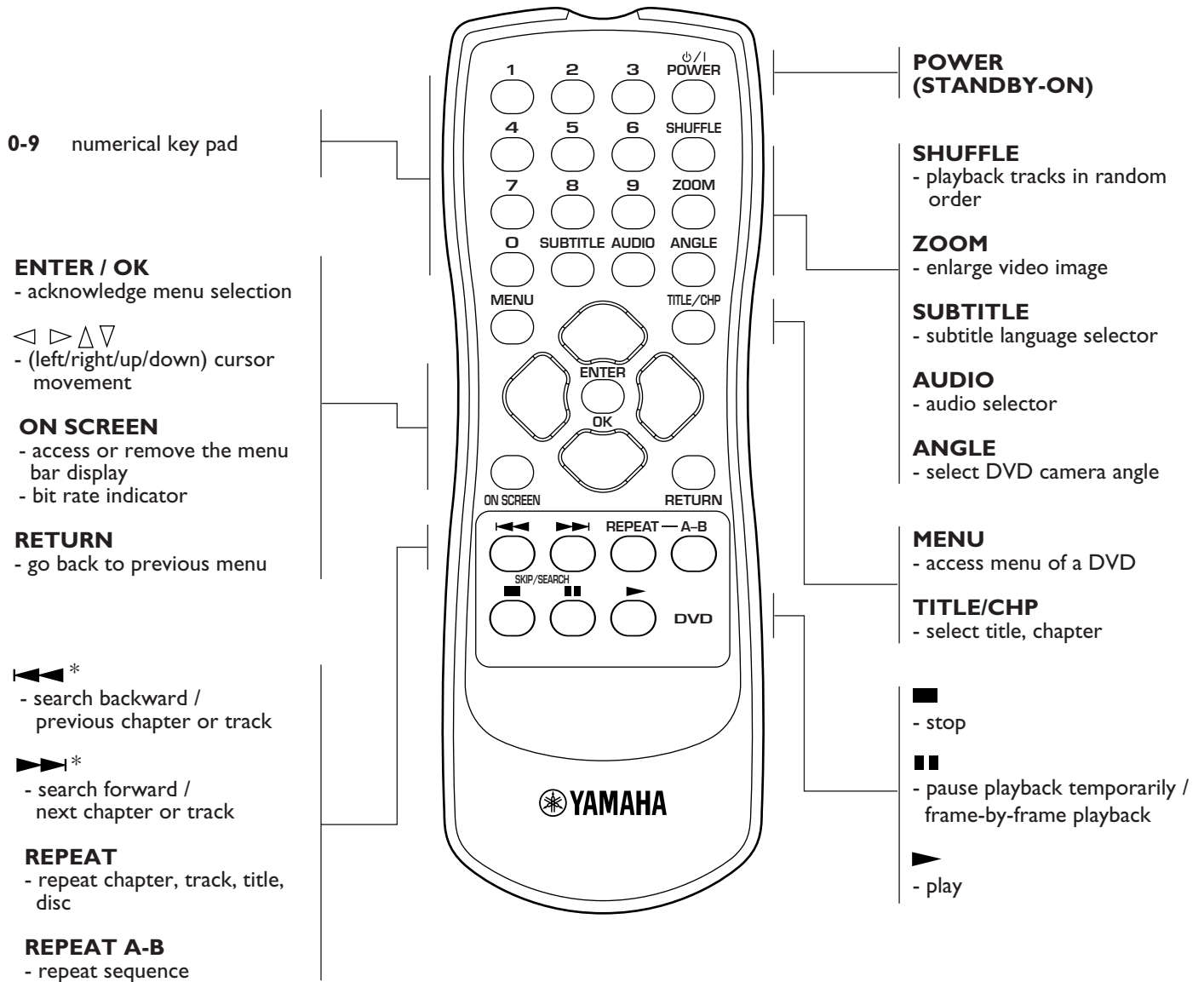

* Press key for about 2 seconds

On screen display information

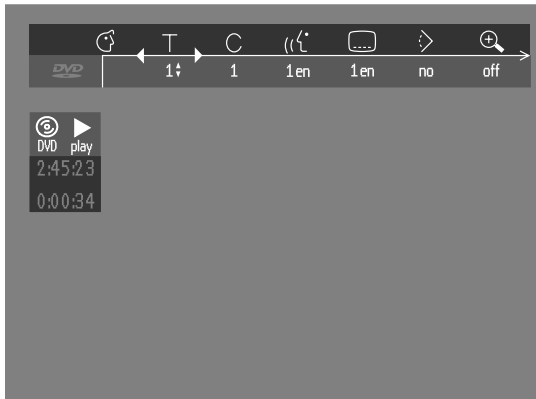

Menu bar/Status window

	Personal Preferences		Slow motion
	Title/Track		Fast motion
	Chapter/Index		Time search
	Audio		
	Subtitle language		
	Angle		
	Zoom		
	Video Program		
	Sound		
	Picture by Picture		



Status window icons

The status window displays the current status of the player and appears with the first part of the menu bar. (You must activate this in the Features Menu - see Personal Preferences for details).

General

Disc type

Tray status

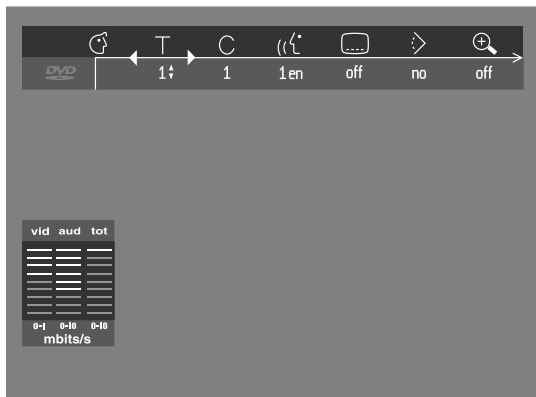

Bit Rate Indicator

When activated, the bit rate for video, audio as well as total bit rate is displayed. This is only applicable during playback of DVD & SVCD discs.

- To activate this, hold down ON SCREEN about two seconds.









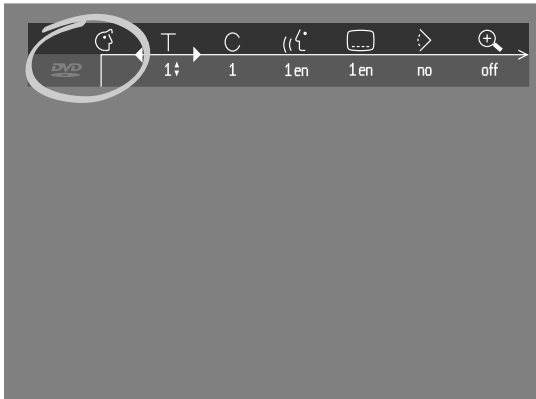





Default screen

The default screen is displayed when the player is in STOP mode. It may contain a 'Status Window' and a 'Temporary Feedback Field'. This gives information concerning prohibited actions, playback modes, available angles, etc.

Temporary Feedback Field icons



	Repeat All
	Repeat Title
	Repeat Track
	Repeat Chapter
	Shuffle
	Shuffle Repeat
	Repeat A to end
	Repeat A-B
	Angle
	Child Lock On
	Child Safe
	Resume
	Action prohibited

Preparation

General notes

- Depending on the equipment you wish to connect, there are various ways you could connect the player. Possible connections are shown in the following drawings.
- Please refer to the manuals of other equipment as necessary to make the best connections.
- Do not connect your DVD-player via your VCR. The video quality could be distorted by the copy protection system.

Digital Connections

Your DVD-Player has COAXIAL and OPTICAL digital out jacks. Connect one or both of them to your AV receiver equipped with Dolby digital, DTS, or MPEG decoder using each specific cable (separate purchase).

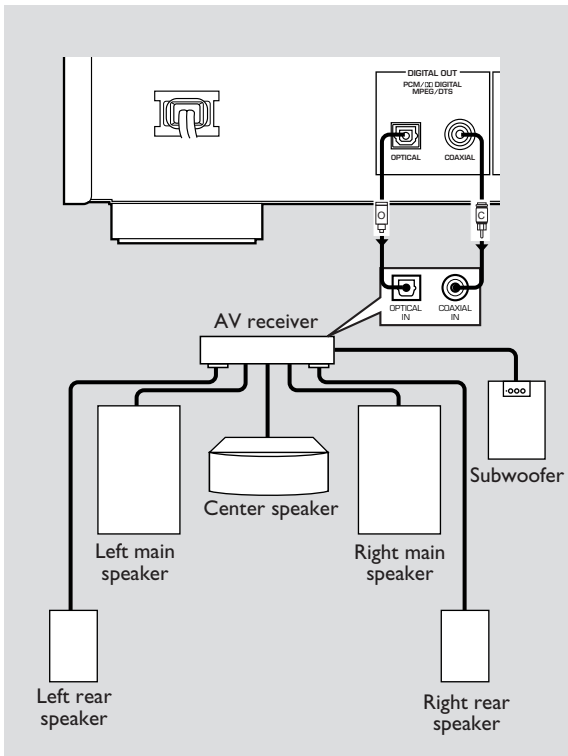

You will need to activate the player's digital output (see 'Personal Preferences').

Note: If the audio format of the digital output does not match the capabilities of your receiver, the receiver will produce a strong, distorted sound or no sound at all. Make sure to select the appropriate audio format at menu screen included on the disc. Pressing AUDIO once or more may change not only audio languages but also audio formats, and the selected format appears for several seconds on the status window.

When connecting the optical fiber cable

- Remove the cover when using the OPTICAL jack. Keep the cover and attach it when the jack is not being used to protect it from dust.
- Bend an optical cable as little as possible.
- Use commercially available optical fiber cable that conforms to EIA standards. Other cables may not function correctly.

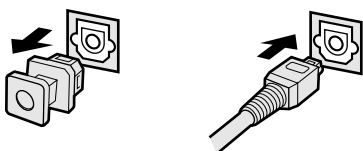

Analog Connections

Connect AUDIO OUT L (left) and R (right) jacks of this DVD player to corresponding input jacks of your audio equipment such as AV receiver.

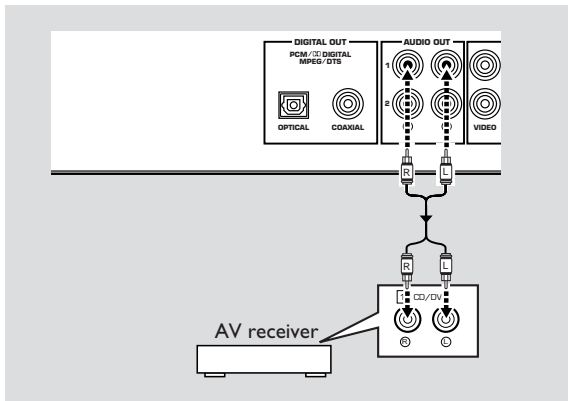

Video Connections

If your AV receiver has video output jacks, connect your receiver (and then to your TV) so that you can use one TV for several different video sources (LD, VCR etc.) by simply switching the input source selector of your receiver. This DVD player has three types of video output jacks. Use one of them in accordance with the input jacks of the equipment to be connected.

Component Video terminal <A>

Component video connection achieves high fidelity in reproducing colors (better performance than S-video connection), separating video signal into luminance (Y, terminal color-coded as green), and color difference (P_B, blue/P_R, red). Use commercially available coaxial cables. Receiver (and TV) with component input is required. Observe the color of each jack when connecting. If your receiver does not have component output jacks, connecting this DVD player's component output directly to your TV's component input can reproduce better video image.

Note

- Do not connect this DVD player's COMPONENT VIDEO OUT jacks to component video input jacks special for HD (High-Definition) TV.

S-Video terminal

S (separate) video connection achieves a clearer picture than composite video connection by separating color and luminance when transmitting signals. Use commercially available S-video cable. Receiver (and TV) with S-video input is required.

Composite Video terminal (1, 2) <C>

Use RCA video cable supplied with this DVD player when connecting this DVD player to a TV.

VIDEO 1, 2 jacks of VIDEO OUT output the same signal. You can connect one to your receiver's input using supplied RCA cable, and the other to another receiver or a TV.

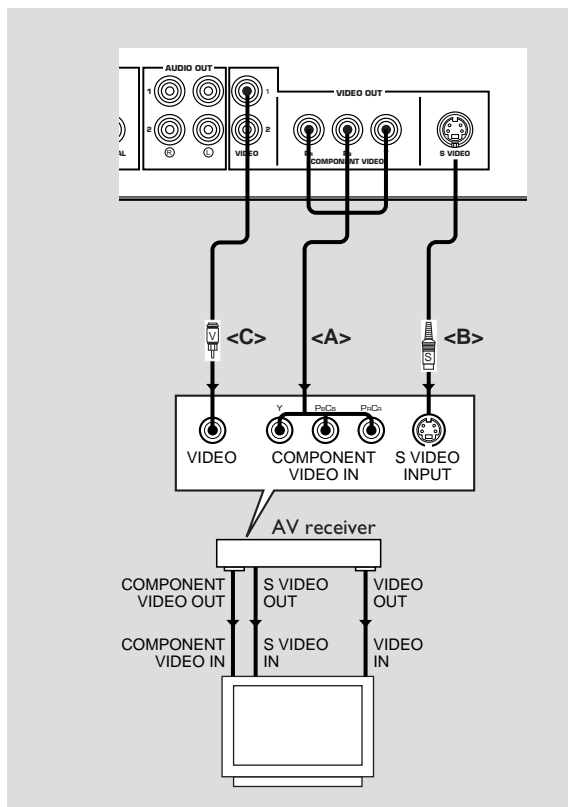

Connecting the power cord

After completing all connections, connect the AC power cord to an AC power outlet

Note: When the player is in the "STANDBY" mode, it is still consuming some power. If you wish to disconnect your player completely from the power, press the POWER button.

Caution: Only qualified service personnel should remove the cover or attempt to service this device.

Remote control battery installation

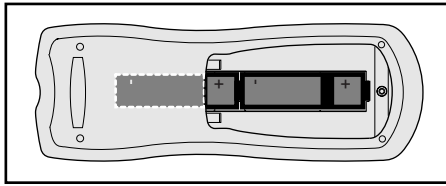

Loading the batteries

- 1 Open the battery compartment cover.
- 2 Insert batteries as indicated inside the battery compartment.
- 3 Close the cover.

Caution: Do not mix old and new batteries. Never mix different types of batteries (standard, alkaline, etc.).

NTSC/PAL Settings

You can switch the NTSC/PAL setting of the DVD player to match the video signal of your TV. This setting only affects the television's on-screen display that shows the stop and setup modes. You may select either NTSC or PAL. To change the DVD player setting to PAL or NTSC, follow the steps below.

- 1 Press the POWER button on the front panel of the DVD player to turn off the DVD player.
- 2 Press and hold ■ and ►►/►►| on the front of the DVD player. While holding ■ and ►►/►►|, press the POWER button.
- 3 After PAL or NTSC appears on the display panel of the DVD player, release ■ and ►►/►►| at the same time. The PAL or NTSC that appears on the display panel indicates the current setting.
- 4 To change the setting, press ►►/►►| within three seconds. The new setting (PAL or NTSC) will appear on the display panel.

General explanation













About this manual

This manual gives the basic instructions for operating this DVD player. Some DVDs require specific operation or allow only limited operation during playback. In these cases, the player may not respond to all operating commands. When this occurs, please refer to the instructions contained with the DVD. When the symbol ✕ appears on the TV screen, the operation is not permitted by the player or the disc.

Remote control operation

- Unless otherwise stated, all operations can be carried out with the remote control. Always point the remote control directly at the player, making sure there are no obstructions in the path of the infrared beam. When there are corresponding keys on the front panel of the player, they can also be used.

Menu bar operation

- A number of operations can be carried out via the menu bar on the screen. The menu bar can be accessed by pressing any of the following keys on the remote control: ON SCREEN, TITLE/CHP, ANGLE, AUDIO, SUBTITLE and ZOOM.
- The following functions are available via the menu bar:
 -  Personal Preferences
 -  Title/Track
 -  Chapter/Index
 -  Audio
 -  Subtitle language
 -  Angle
 -  Zoom
 -  Video Program
 -  Sound
 -  Picture by Picture
 -  Slow motion
 -  Fast motion
 -  Time search
- The various items can be selected by pressing the ON SCREEN button, then the ▼/▲ keys or by pressing relevant keys on the remote control.
- Pressing ON SCREEN while the menu bar is displayed will clear the menu bar from the screen.
- When selecting an item in the menu bar, the selected item will be highlighted and the appropriate cursor keys to operate this item will be displayed below the icon.
- < or > indicates that more items are available at the left/right of the menu bar. Press ◀ or ▶ to select these items.

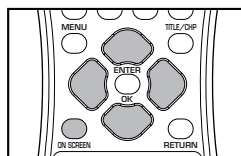

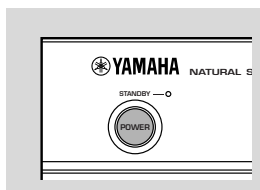

Turning On the power

- 1 Switch on the TV and select the video input channel for your DVD-Video player.
- 2 Press POWER button.

Initial Setup

General

In 'Initial Setup' you may have to set your preferences for some of the player's features. *(not applicable for all models)*



* Menu items vary between models

Operation

After switching on the player for the very first time, the 'Initial Setup Screen' will appear.

The menu for the first item to be set is displayed and the first option is highlighted.

- Use the ▼ ▲ keys to go through the options in the menu. The icon of the selected option will be highlighted.
- Use OK to confirm your selection and to go to the next menu.

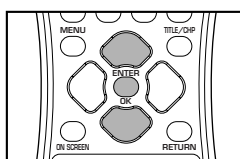

Note: Preferences have to be set in the order in which the item menus will appear on the screen.

The 'Initial Setup' screen will only disappear after the settings for the last item have been confirmed.

If any keys other than ▼ ▲ or OK are pressed, ✕ will appear on the screen.

If the player is switched off while setting personal preferences, all preferences have to be set again after switching the player on again.



* Menu items vary between models



The following items may have to be set in Initial Setup:

Menu language

The On Screen Menus will be displayed in the language you choose. You can choose from different languages.

Audio language

The sound will be in the language you choose if it is available on the disc in play. If the language you select is not available, speech will revert to the first spoken language on the disc. You can choose from different languages.

Subtitle language

The subtitles will be in the language you choose if it is available on the disc in play. If the language you select is not available, subtitles will revert to the first subtitle language on the disc. You can choose from different languages.

TV Shape

If you have a wide screen (16:9) TV, select 16:9.

If you have a regular (4:3) TV, select 4:3.

If you have a 4:3 TV, you can also select between:

Letterbox for a 'wide-screen' picture with black bars top and bottom, or Pan Scan, for a full-height picture with the sides trimmed. If a disc has Pan Scan, the picture then moves (scans) horizontally to keep the main action on the screen.

Country

Select your country. This also is used as input for the 'Parental Control' feature (see 'Access Control').

Note: All these items may have to be set during 'Initial Setup'. After that, they can always be changed in the Personal Preferences Menu.

Personal Preferences

You can set your personal preferences for some of the player features.

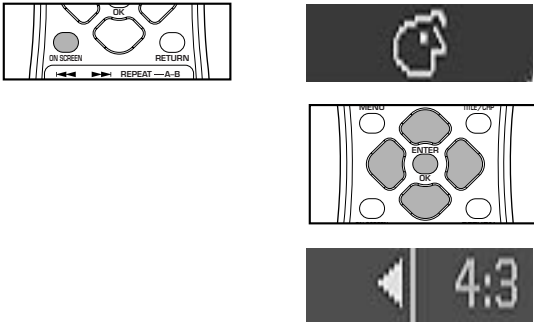

General operation:

- Press ON SCREEN on the remote control.
- Select  in the menu bar.
 - The Personal Preferences menu appears.
- Use the ◀ ▶ ▼ ▲ keys to toggle through the menus, submenus and submenu options.
 - When a menu item is selected, the cursor keys (on the remote control) to operate the item are displayed next to the item.
- Press OK to confirm and return to the main menu.

The following items can be adapted:

Picture

-TV Shape

See 'Initial Setup'

- Black level shift (NTSC only)

Select ON for adapting the color dynamics to obtain richer contrasts.

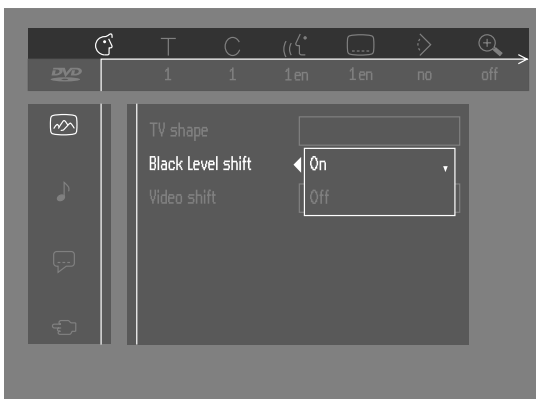

- Video shift

The factory centers the video on your screen. Use this setting to personalize the position of the picture on your TV by scrolling it to the left or right.

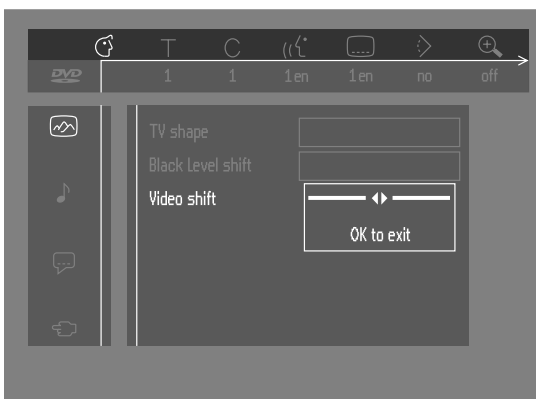

Sound

- Digital output

Factory setting: ALL. This means that both coaxial and optical outputs are switched on. If you are not connecting equipment with a digital input, change the setting to OFF.

If your equipment doesn't include a digital multi-channel decoder, set the digital output to PCM only. Both coaxial and optical outputs are switched on.

Note:

- When the setting is ALL, make sure that the selected audio format of the disc you play matches the connected equipment's capability. If a digital signal which the equipment cannot handle is output, there may be a noise and that could damage your ears and your speakers.
- When CDs were put on the market in the early stage, high tones from some of them would be heard as punch lacked.

- Analog output

Select Stereo, Dolby Surround or 3D sound.

- Night Mode

Optimizes the dynamics of the sound with low volume playback.

- Karaoke vocal

Put this setting to ON only when a multi-channel karaoke DVD is being played. The karaoke channels on the disc will then be mixed to a normal stereo sound.

Language

Select the required Menu, Audio and Subtitle language. See 'Initial Setup'. Audio language and Subtitle language can also be adapted via the Menu bar on the screen.

Features

- Access Control

Access Control contains the following features:

Child Lock - When Child Lock is set to ON, a 4-digit code needs to be entered in order to play discs.

Parental control - Allows the conditional presentation of DVDs containing Parental Control information (see 'Access Control').

- Status Window

Displays the current status of the player and is displayed with the menu bar. When disc playback is stopped, it is displayed with the 'Temporary Feedback Field' in the default screen. See 'On-Screen Display information'; Factory setting is ON. Select OFF to suppress display of the Status Window.

- Low Power Standby

This setting is effective for Europe and U.K. models, when the DVD player is connected between your TV and VCR with SCART cables. If you use TV and VCR while the DVD player is turned off, set Low Power Standby to OFF. Otherwise VCR does not function.

- PBC

Some Video CDs have PBC (Playback control). When activated, a menu screen included on the disc appears soon after playback starts.

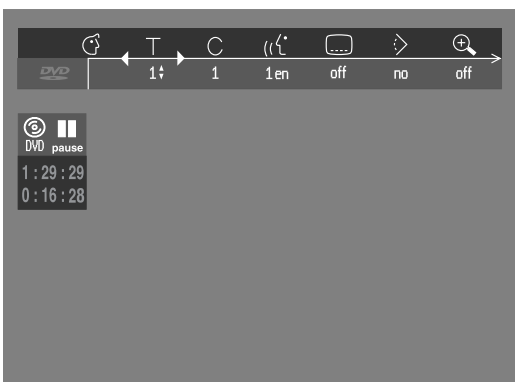

Access control; child lock (DVD and VCD)

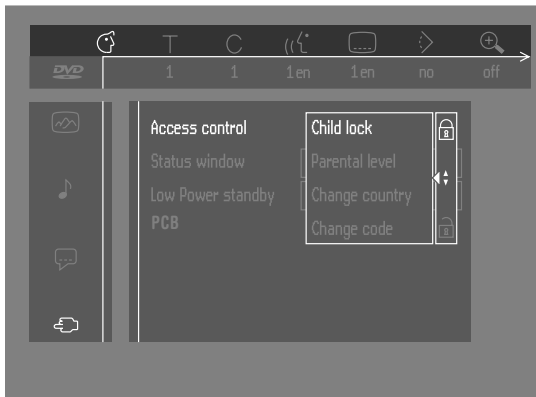

Activating/deactivating the child lock

- 1 When disc playback is stopped, select Access Control in the features menu using the ▼/▲ keys.
- 2 Enter a 4-digit code of your own choice.
- 3 Enter the code a second time.
- 4 Move to Child Lock using the ▼/▲ keys.
- 5 Move to LOCK/UNLOCK using the ► key.
- 6 Select LOCK using the ▼/▲ keys.
- 7 Press OK or ◀ to confirm, then press ◀ again to exit the menu.
 - Now unauthorized discs will not be played unless the 4-digit code is entered.
- 8 Select UNLOCK to deactivate the Child Lock.

Note: Confirmation of the 4-digit code is necessary when:

- The code is entered for the very first time (see above),
- The code is changed (see 'Changing the 4-digit code'),
- The code is cancelled (see 'Changing the 4-digit code').

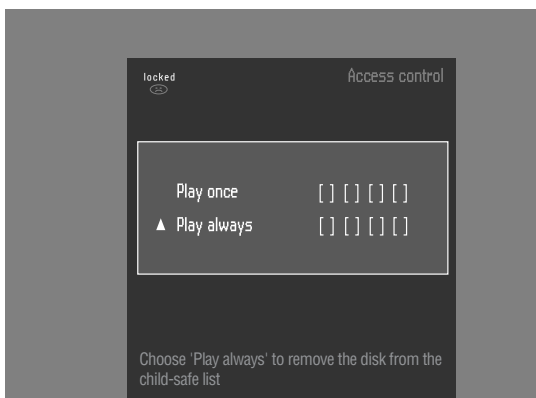

Authorizing discs

- Insert the disc. See 'Loading disc'.

➤ The 'child protect' dialog will appear.

You will be asked to enter your secret code for 'Play Once' or 'Play Always.' If you select 'Play Once', the disc can be played as long as it is in the player and the player is ON. If you select 'Play Always', the disc will become child safe (authorized) and can always be played, even if the Child Lock is set to ON.

Notes: The player memory maintains a list of 50 authorized ('Child safe') disc titles. A disc will be placed in the list when 'Play Always' is selected in the 'child protect' dialog. Each time a 'child safe' disc is played, it will be placed on top of the list. When the list is full and a new disc is added, the last disc in the list will be removed from the list.

Double sided DVDs may have a different ID for each side. In order to make the disc 'child safe', each side has to be authorized.

Multi-volume VCDs may have a different ID for each volume. In order to make the complete set 'child safe', each volume has to be authorized.

Deauthorizing discs

- Insert the disc. See 'Loading disc'.
 - Playback starts automatically.
- Press ■ while 😊 is visible.
 - The 😞 will appear and the disc is now deauthorized.

Access control; Parental control (DVD-Video only)

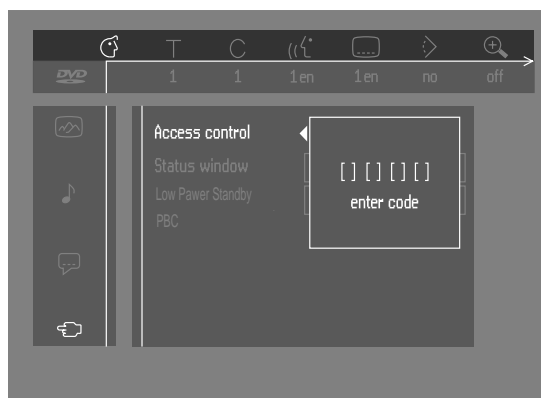

Movies on DVDs may contain scenes not suitable for children. Therefore, disc may contain 'Parental Control' information which applies to the complete disc or to certain scenes on the disc. These scenes are rated from 1 to 8, and alternative, more suitable scenes are available on the disc. Ratings are country dependent. The 'Parental Control' feature allows you to prevent discs from being played by your children or to have certain discs played with alternative scenes.

Activating/Deactivating Parental Control

- 1 When disc playback is stopped, select Access Control in the features menu using the ▼/▲ keys.
- 2 Enter your 4-digit code. If necessary, enter the code a second time.
- 3 Move to Parental Control using the ▼/▲ keys.
- 4 Move to Value Adjustment (1-8) using the ► key.
- 5 Then use the ▼/▲ keys or the numerical keys on the remote control to select a rating from 1 to 8 for the disc inserted.

Rating 0 (displayed as '- -'):

Parental Control is not activated. The Disc will be played in full.

Ratings 1 to 8:

The disc contains scenes not suitable for children. If you set a rating for the player, all scenes with the same rating or lower will be played. Higher rated scenes will not be played unless an alternative is available on the disc. The alternative must have the same rating or a lower one. If no suitable alternative is found, play will stop and the 4-digit code has to be entered.

- 6 Press OK or ◀ to confirm, then press ◀ again to exit the menu.

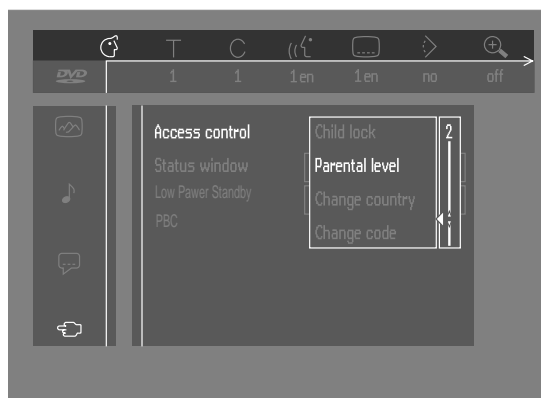

Country

- 1 When disc playback is stopped, select Access Control in the features menu using the ▼/▲ keys.
- 2 Enter the 4-digit code.
- 3 Move to Change Country using the ▼ key.
- 4 Press the ► key.
- 5 Select a country using ▼/▲.
- 6 Press OK or ◀ to confirm, then press ◀ again to exit the menu.

Changing the 4-digit code

- 1** When disc playback is stopped, select Access Control in the features menu using the ▼/▲ keys.
- 2** Enter the old code.
- 3** Move to Change Code using the ▼ key.
- 4** Press the ► key.
- 5** Enter the new 4-digit code.
- 6** Enter the code a second time and reconfirm by pressing OK.
- 7** Press ◀ to exit the menu.

Note: If you forget your 4 digit code, it can be cancelled by pressing ■ four times in the 'Access Control' dialog. You can then enter a new code (twice!) as described above.

Parental Control Disclaimer

This DVD player features the PARENTAL CONTROL system which is intended to activate when playing DVD discs furnished with certain software coding. This is according to technical standards adopted by the set maker and disc content industries.

Please note that the PARENTAL CONTROL system will not operate a DVD disc which is not furnished with the appropriate software coding. Also note that at the time of release of this DVD player, certain aspects of the technical standards had not been settled between set makers and the disc industries. On this basis YAMAHA cannot guarantee functioning of the PARENTAL CONTROL system and denies any liability associated with unintended watching of disc content.

If in doubt, please make sure the disc plays according to your PARENTAL CONTROL settings before you allow children access.

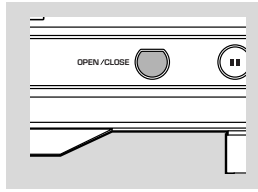

Loading discs

- 1 Press **OPEN/CLOSE** on the front of the player. The disc tray opens.
- 2 Load your chosen disc in the tray, label side up (also when a double sided DVD is inserted). Make sure it is sitting properly in the correct recess.
- 3 Press **OPEN/CLOSE**, to close the tray.

- **READY** appears in the status window and on the player display, and playback starts automatically.

Note: If 'Child Lock' is set to ON and the disc inserted is not in the 'child safe' list (not authorized), the 4-digit code must be entered and/or the disc must be authorized (see 'Access Control').

Playing a DVD-video disc



Playing a title

- After inserting the disc and closing the tray, playback starts automatically and the status window and the player display show the type of disc loaded, as well as information about the disc's contents and playing time. The disc may invite you to select an item from a menu. If the selections are numbered, press the appropriate numerical key; if not, use the **▼/▲**, **◀/▶** keys to highlight your selection, then press **OK**.

- The currently playing title and chapter number are displayed in the menu bar and the player display.

The elapsed playing time is shown in the status window and the player display.

- If required, you can select Stereo, Dolby Surround or 3D-Sound by using the **↔** (Sound) in the menu bar. Play may stop at the end of the Title, and the player may return to the DVD menu. To go on to the next title, press **▶**.
- To stop play at any other time, press **■**.
 - The default screen will appear, giving information about the current status of the player.
- You can resume play from the point at which you stopped play. Press **▶**; when you see the Resume icon **▶** on the screen, press **▶** again.
 - The **RESUME** feature applies not only to the disc in the player, but also to the last four discs you have played. Simply reload the disc and press **▶**; when you see the Resume icon **▶** on the screen, press **▶** again.

Note: Since it is usual for DVD movies to be released at different times in different regions of the world, all players have region codes. Discs can have an optional region code. If you load a disc of a different region code into your player, you will see the region code notice on the screen. The disc will not play and should be removed from the player.

Playing a Video CD

Playing a disc



- After inserting the disc and closing the tray, playback starts automatically and the status window and the player display show the type of disc loaded, as well as information about the disc's contents and playing time.
 - The disc may invite you to select an item from a menu. If the selections are numbered, press the appropriate numerical key.
 - The currently playing track number is displayed in the menu bar and the player display. The elapsed playing time is shown in the status window and the player display.
 - If required, you can select Stereo, Dolby Surround or 3D-Sound by using the (Sound) in the menu bar.
 - To stop play at any time, press .
 - The default screen will then appear.
 - You can resume play from the point at which you stopped play. Press ; when you see the Resume icon on the screen , press again.
- The resume feature applies not only to the disc in the player, but also to the last four discs you have played. Simply reload the disc and press ; when you see the Resume icon on the screen, press again.

General features



Note: Unless stated otherwise, all operations described are based on remote control operation. A number of operations can also be carried out via the menu bar on the screen (see 'Menu bar operation').

Moving to another title/track

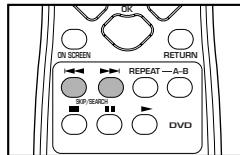
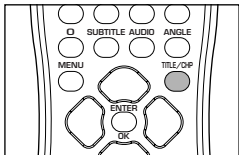

When a disc has more than one title or track (which you can see from both the menu bar and the player display), you can move to another title as follows:

- Press TITLE/CHP (title/chapter), then press briefly during play to select the next title/track.
- Press TITLE/CHP (title/chapter), then press briefly during play to return to the beginning of the current title/track. Press **twice** briefly to step back to the previous title/track.
- If the player skips a chapter/Index, show the menu bar and select (Title/Track) to skip title/track(s).

Moving to another chapter/index

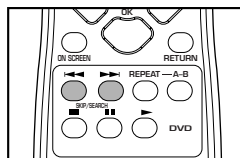



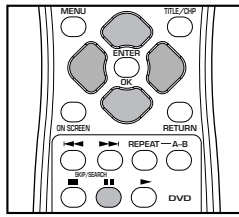

When a title on a disc has more than one chapter or a track has more than one index (which you can see from the player display and on the menu bar), you can move to another chapter/index as follows:

- Press briefly during play to select the next chapter/index.
- Press briefly during play to return to the beginning of the current chapter/index. Press **twice** briefly to step back to the previous chapter/index.
- To go directly to any chapter or index, select TITLE/CHP (title/chapter), then enter the chapter/index number using the numerical keys (0-9).
- If the player skips a title/track, show the menu bar and select (Chapter/Index) to skip chapter/index(s).

Note: If the number has more than one digit, press the keys in rapid succession.



Still Picture and Frame-by-frame playback





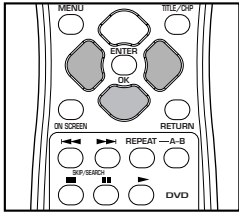

- Select  (picture by picture) in the menu bar.
- Use the  key to enter the picture by picture menu.
 - The player will now go into PAUSE mode.
- Use the cursor keys   to select the previous or next picture frame.
- To exit Picture by picture mode, press .

You can also step forward by pressing  repeatedly.

Pressing the  key while the menu bar is turned off also makes the player go into pause mode.







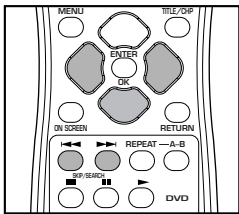





Slow motion

- Select  (Slow motion) in the menu bar.
- Use the  keys to enter the Slow Motion menu.
- Use the   keys to select the required speed: -1, -1/2, -1/4 or -1/8 (backward), or 1/8, 1/4, 1/2, 1 (forward).
- To exit Slow Motion mode, press .
- Select 0 to pause playback.
- Pressing the  key while the menu bar is turned off allows you to play forward at different slow speeds.



Search

- Select  (Fast motion) in the menu bar.
- Use the  keys to enter the Fast Motion menu.
- Use the   keys to select the required speed: -32, -8 or -4 (backward), or 4, 8, 32 (forward).
- Select 1 to play at normal speed again.
- To exit Fast Motion mode, press .

To search forward or backward through different speeds (x 4, x 32), you can also hold down   or   or press the cursor keys   while the menu bar is turned off.

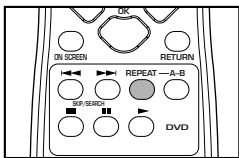

Repeat

DVD-Video Discs - Repeat chapter/title/disc

- To repeat the currently playing chapter, press **REPEAT**.
 - **REPEAT CHAPTER** appears on the player display.
- To repeat the title currently playing, press **REPEAT** a second time
 - **REPEAT TITLE** appears on the display.
- To repeat the entire disc, press **REPEAT** a third time
 - **REPEAT** appears on the display.
- To exit Repeat mode, press **REPEAT** a fourth time.

Video CDs - Repeat track/disc

- To repeat the track currently playing, press **REPEAT**.
 - **REPEAT TRACK** appears on the player display.
- To repeat the entire disc, press **REPEAT** a second time.
 - **REPEAT** appears on display and screen.
- To exit Repeat mode, press **REPEAT** a third time.

Note: This function is not available with video CD's version 2.0 when PBC under Personal Preferences is set to ON.

Repeat A-B

To repeat a sequence in a title:

- Press **REPEAT A-B** at your chosen starting point;
 - **A-** appears briefly on the screen.
- Press **REPEAT A-B** again at your chosen end point;
 - **A-B REPEAT** appears briefly on the display, and the repeat sequence begins (**A-B** is displayed on the front panel of the player).

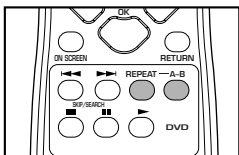

- To exit the sequence, press **REPEAT A-B**.

Note: This function is not available with video CD's version 2.0 when PBC under Personal Preferences is set to ON.

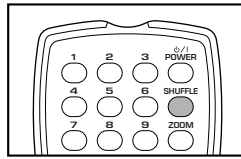

Shuffle

DVD-Video discs

This shuffles the playing order of chapters within a title, if the title has more than one.

- Press **SHUFFLE** during play.
 - SHUFFLE appears on the screen for about 2 seconds.
- To return to normal play, press **SHUFFLE** again.

Video CDs

This shuffles the playing order of the tracks, if the disc has more than one.

- Press **SHUFFLE** during play.
 - SHUFFLE appears on the screen for about 2 seconds.
- To return to normal play, press **SHUFFLE** again.

Note: This function is not available with video CD's version 2.0 when PBC under Personal Preferences is set to ON.



Time search

The Time Search function allows you to start playing at any chosen time on the disc.

- Select **⏮** (Time Search) in the menu bar.
- Press **▼**.
 - The player will now go into pause mode.
 - A time edit box appears on the screen, showing the elapsed playing time of the current disc.
- Use the digit keys to enter the required start time. Enter hours, minutes and seconds from left to right in the box.
 - Each time an item has been entered, the next item will be highlighted.
- Press **OK** to confirm the start time.
 - The time edit box will disappear and play starts from the selected time position on the disc.

Note: This function is not available with video CD's version 2.0 when PBC under Personal Preferences is set to ON.

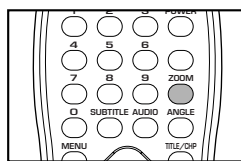

Zoom

The Zoom function allows you to enlarge the video image and to pan through the enlarged image.

- Select **⏏** (Zoom) in the menu bar.
- Press **▼/▲** to activate the ZOOM function and select the required zoom factor: 1.33 or 2 or 4.
 - The player will go into Pause mode.
 - The selected zoom factor appears below the Zoom icon in the menu bar and 'Press OK to pan' appears below the menu bar.
 - The picture will change accordingly.
- Press **OK** to confirm the selection.
 - The panning icons appear on the screen: **▲ ▼ ◀ ▶** and **OK**.
- Use the **▲ ▼ ◀ ▶** keys to pan across the screen.
- When **OK** is pressed only the zoomed picture will be shown on the screen.
- If you wish to zoom at any moment, press **⏏** (Zoom) and select the required zoom factor as described above.
- To exit Zoom mode:
 - Press **▶** to resume playback, press **STOP** to stop, or press **ON SCREEN** to pause.

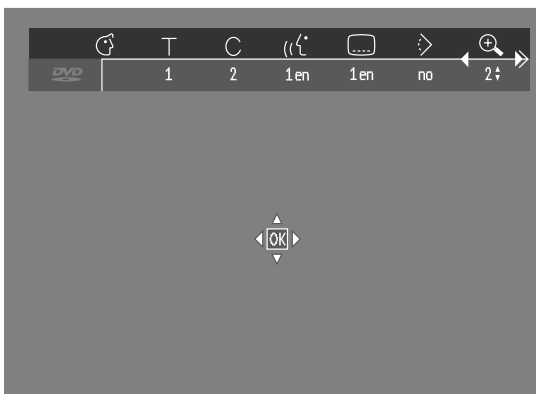
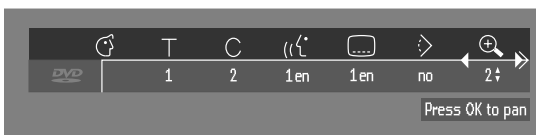

FTS (Favorite Track Selection) -Video

- The FTS-Video function allows you to store your favorite titles and chapters (DVD) and favorite tracks and indexes (VCD) for a particular disc in the player memory.
- Each FTS program can contain 20 items (titles, chapters).
- The selections can be called up and played at any time.

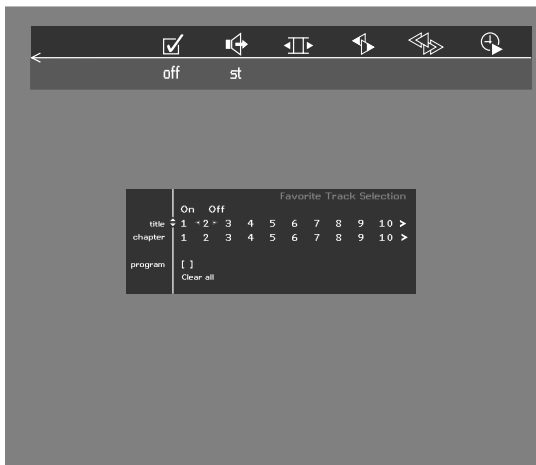

Storing a FTS-Video Program

- In STOP mode, select **Video FTS** in the menu bar.
- Press **▼** to open the menu.
 - The **Video FTS** menu appears.
- Press **◀** or **▶** or **FTS** to select **ON** or **OFF**.

Storing titles/tracks

- Press **▼** to select **TITLES**.
- Use **◀** or **▶** to select the required title.
- Press **OK** if you wish to store the entire title.
 - The title number will be added to the list of selections.

Storing chapters/indexes

- Press **▼** on the selected title number.
 - The title number will be marked and the highlight moves to the first available chapter number for this title.
- Use **◀** or **▶** to select the required chapter number.
- Press **OK** to confirm the selection.
 - The title/chapter selection will be added to the list of selections.
- Press **ON SCREEN** to exit the **Video FTS** menu.

Erasing a FTS-Video Program

- In STOP mode, select **Video FTS** in the menu bar.
- Use **▼** to select **PROGRAM**.
- Use **◀** or **▶** to select the required selection number.
- Press **OK** to erase the selection.
- Press **ON SCREEN** to exit.

If you wish to erase all selections:

- In STOP mode, select **Video FTS** in the menu bar.
- Use **▼** to select **CLEAR ALL**.
- Press **OK**.
 - All selections will now be erased.
- Press **ON SCREEN** to exit.

Note: This function is not available with video CD's version 2.0 when PBC under Personal Preferences is set to ON.

Special DVD features

Checking the contents of DVD-Video discs: Menus

For titles and chapters, selection menus may be included on the disc. The DVD's menu feature allows you to make selections from these menus. Press the appropriate numerical key; or use the **▼**, **▲**, **▶**, **◀** keys to highlight your selection, then press **OK**.

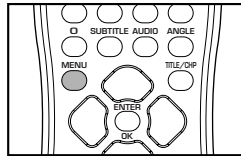

Title menu

- Press **MENU**.
 - ▶ If the current title has a menu, the menu will appear on the screen. If no menu is present in the title, the disc menu will be displayed.
- The menu can list camera angles, spoken language and subtitle options, and chapters for the title.
- To remove the title menu, press **MENU** again.

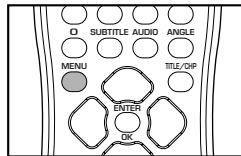
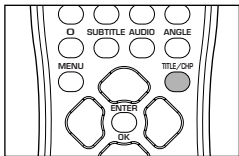

Disc menu

- Press TITLE/CHP then press **MENU**.
 - ▶ The disc menu is displayed.
- To remove the disc menu, press TITLE/CHP, then press **MENU**.





Camera Angle

If the disc contains sequences recorded from different camera angles, the angle icon appears, showing the number of available angles and the angle being shown currently. You can then change the camera angle if you wish.

- Use the **▼**/**▲** keys to select the required angle in the angle icon.
 - ▶ After a small delay, play changes to the selected angle. The angle icon remains displayed until multiple angles are no longer available.





Audio

- Select  (Audio) in the menu bar.
- Press  or **▼**/**▲** repeatedly to see the different audio languages and/or formats.



Subtitles

- Select  (Subtitle) in the menu bar.
- Press  or **▼**/**▲** repeatedly to see the different subtitles.

Special VCD-Features

Playback Control (PBC)

- Load a Video CD with PBC and press ►.
- Go through the menu with the keys indicated on the TV screen until your chosen passage starts to play. If a PBC menu consists of a list of titles, you can select a title directly.
- Enter your choice with the numerical keys (0-9).
- Press **RETURN** to go back to the previous menu.
- You may also set the PBC OFF under Personal Preferences menu.

Note: When PBC is on, you cannot operate shuffle, repeat, A-B repeat, time search and FTS video with video CD's version 2.0.

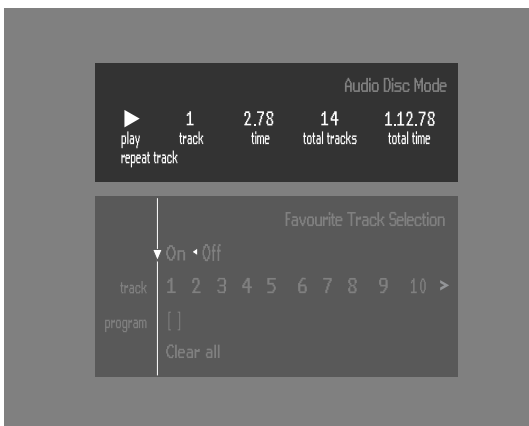

Playing an audio CD

- After loading the disc, playback starts automatically.
- If the TV is on, the Audio CD screen appears.
- The number of tracks and the total playing time will be shown on the screen.
- During play, the current track number and its elapsed playing time will be shown on the screen and on the player display.
- Playback will stop at the end of the disc.
- To stop play at any other time, press ■.

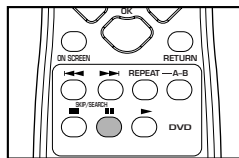

Pause

- Press **II** during play.
- To return to play, press ►.

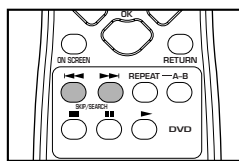

Search

- To search forward or backward through the disc at four times normal speed, hold down **◀◀** or **▶▶** for about one second during play.
 - ▶ Search begins, and sound is partially muted.
- To step up to eight times the normal speed, press **◀◀** or **▶▶** again.
 - ▶ Search goes to eight times the speed, and the sound is muted.
- To return to four times the normal speed, press **◀◀** or **▶▶** again.
- If the TV is on, search speed and direction are indicated on the screen each time **◀◀** or **▶▶** is pressed.
- To end the search, press ► to resume playback or ■ to stop.

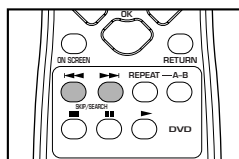

Moving to another track

- Press **▶▶** briefly during play to go to the next track.
- Press **◀◀** briefly during play to return to the beginning of the current track. Press **◀◀** **twice** briefly to step back to the previous track.
- To go directly to any track, enter the track number using the numerical keys **(0-9)**.

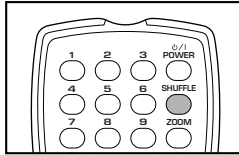

Shuffle

- Press **SHUFFLE** during play.
 - The order of the tracks is changed.
- To return to normal play, press **SHUFFLE** again.

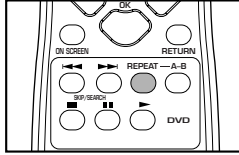

Repeat track/disc

- To repeat the track currently playing, press **REPEAT**.
 - **REPEAT TRACK** appears on the display.
- To repeat the entire disc, press **REPEAT** a second time.
 - **REPEAT** appears on the display.
- To exit Repeat mode, press **REPEAT** a third time.

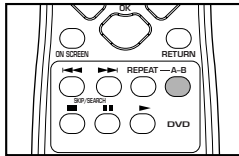

Repeat A-B

To repeat a sequence:

- Press **REPEAT A-B** at your chosen starting point;
 - **A-** appears on the player display.
- Press **REPEAT A-B** again at your chosen end point;
 - **A-B** appears on the display, and the sequence begins to play repeatedly.
- To exit the sequence, press **REPEAT A-B** again.

FTS (Favorite Track Selection) Program

- FTS Program allows you to store your favorite tracks for a particular disc in the player memory.
- Each FTS Program can contain 20 tracks.

Storing an FTS Program

- 1 Load a disc and stop playback.
- 2 Use ▼ to go to the list of available tracks.
- 3 Use ◀ or ▶ to select tracks from the list.
To go directly to any track, enter the track number using the numerical keys (0-9).
- 4 Store each track by pressing **OK**.
 - The track numbers will be added to the list of selected tracks.
 - The number of tracks and the playing time of the program will be shown on the screen and the player display.

When your FTS Program is complete, press ▶ to start play, or ▲ to go back to Stop mode. In either case, the FTS Program will be automatically memorized.

Switching FTS ON/OFF

- 1 Use ▲/▼ to move to the top.
- 2 Use ◀ or ▶ to select either ON or OFF.

Erasing a track from an FTS Program

- 1 Use ▼ to go to the list of selected tracks.
- 2 Use ◀ or ▶ to select the track number you wish to erase.
- 3 Press **OK**.
 - The track number will be erased from the list of selected tracks.

Erasing the complete program

- Use ▼ to select Clear All, then press **OK**.
 - The complete FTS Program for the disc will be erased.



Before requesting service

If it appears that the DVD-Video player is faulty, first consult this checklist. It may be that something has been overlooked. Under no circumstances attempt to repair the system yourself.

Look for the specific symptom(s). Then perform only the actions listed to remedy the specific symptom(s).

Symptom	Remedy
No power	Make sure the mains cord (AC) is properly connected. Check if there is power at the AC outlet by plugging in another appliance.
No picture	Check if the TV is switched on. Check the video connection.
Distorted picture	Check the disc for fingerprints and clean with a soft cloth, wiping from center to edge. Sometimes a small amount of picture distortion may appear. This is not a malfunction.
Completely distorted picture or no color with player menu.	If the picture is distorted completely or if the picture rolls vertically, make sure the NTSC/PAL setting at the DVD player matches the video signal of your television. If your TV video signal is NTSC, select the NTSC setting at the DVD player. If your video signal is PAL, select the PAL setting - see NTSC/PAL SETTINGS .
Distorted or Black/White picture with DVD or Video CD.	The disc format does not match your TV's video signal (PAL/NTSC).
No sound	Check audio connections. If you are using a HiFi amplifier, try another sound source.
Distorted sound from HiFi amplifier.	Check to make sure that no audio connections are made to the amplifier phono input.
No audio at digital output.	Check the digital connections. Check the settings menu to make sure the digital output is set to ALL or PCM only. Check if the selected audio format matches your receiver capabilities.
Disc can't be played.	Ensure the disc label is facing up. Clean the disc. Check if the disc is defective by trying another disc. Check to see if the disc is defective, badly scratched or warped (not flat)
No return to start-up screen when disc is removed.	Reset by switching the player off, then on again. Check to see if the program requires another disc to be loaded.
The player does not respond to the remote control.	Aim the remote control directly at the sensor on the front of the player. Remove any obstacles between the player and the remote control. Inspect or replace the batteries in the remote control.
Buttons do not work.	In order to completely reset the player, unplug the AC cord from the AC outlet for a few seconds.
Player does not respond to all operating commands during playback.	Operations are not permitted by the disc. Refer to the instructions of the disc.

Cleaning discs

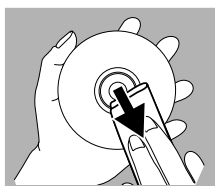

Some problems occur because the disc inside the player is dirty. To avoid these problems clean your discs regularly, in the following way:

- When a disc becomes dirty, clean it with a cleaning cloth. Wipe the disc from the center out.

Caution: Do not use solvents such as benzine, thinner, commercially available cleaners, or anti-static spray intended for analog discs.

Specifications

PLAYBACK SYSTEM

DVD-Video
Video CD
CD (CD-R and CD-RW)

OPTICAL READOUT SYSTEM

Lasertype	Semiconductor AlGaAs
Numerical Aperture	0.60 (DVD) 0.45 (VCD/CD)
Wavelength	650 nm (DVD) 780 nm (VCD/CD)

DVD DISC FORMAT

Medium	Optical Disc
Diameter	12cm (8cm)
Playing time (12cm)	One layer 2.15 h* Dual layer 4 h* Two side 4.30 h* Single layer Two side 8 h* Dual layer

TV STANDARD

	EUROPE	USA
	(PAL/50Hz)	(NTSC/60Hz)
Number of lines	625	525
Playback	Multistandard	(PAL/NTSC)

VIDEO FORMAT

DA Converter	10 bits
Signal handling	Components
Digital Compression	MPEG2 for DVD, MPEG1 for VCD

DVD

Horiz. Resolution	720 pixels**	720 pixels**
Vertical Resolution	576 lines	480 lines

VCD

Horiz. Resolution	352 pixels	352 pixels
Vertical Resolution	288 lines	240 lines

VIDEO PERFORMANCE

Video output	1 Vpp into 75 ohm
S-Video output	Y: 1 Vpp into 75 ohm C: 0.3 Vpp into 75 ohm
Y	1 Vpp into 75 ohm
CR	0.7 Vpp into 75 ohm
Cb	0.7 Vpp into 75 ohm
Black Level Shift	On/Off
Video Shift	Left/Right

AUDIO FORMAT

Digital	MPEG	Compressed Digital
	DTS	Compressed Digital
	AC-3	Compressed Digital/PCM
	PCM	
Analog	Analog Sound Stereo Dolby Pro Logic downmix from AC-3 multi-channel sound 3D Sound for virtual 5.1 channel sound on 2 speakers	

AUDIO PERFORMANCE

DA Converter	24 bits
DVD	fs 48 kHz 2 Hz - 22 kHz
Video CD	fs 44.1 kHz 2 Hz - 20 kHz
CD	fs 44.1 kHz 2 Hz - 20 kHz
Signal-Noise (1kHz)	95 dB
Dynamic Range (1kHz)	95 dB
Harmonic Distortion + Noise (1kHz)	0.0035%

CONNECTIONS

S-Video Output	Mini DIN, 4 pins	
Component Video	Y	Cinch (green)
	U (CR)	Cinch (blue)
	V (Cb)	Cinch (red)
Video Output	Cinch (yellow) x 2	
Audio L+R output	Cinch (white/red) x 2	
Digital Output	1 coaxial, 1 optical IEC958 for CDDA / LPCM IEC1937 for MPEG1/2, AC-3 and DTS	

GENERAL

Dimensions (w x h x d)	435 x 91 x 314 mm
Weight	Approx. 3.3 Kg
Power supply	
U.S.A. and Canada models	120V, 60 Hz
Europe and U.K. models	230V, 50 Hz
Australia model	240V, 50 Hz
General model	110 ~ 240V, 50/60 Hz
Power consumption	20W

PACKAGE CONTENTS

DVD-Video Player
Remote Control & Batteries
AC Power cord
Owner's Manual
Audio/Video cable

GENERAL FUNCTIONALITY

Stop / Play / Pause
Fast Forward / Backward
Time search
Step Forward / Backward
Title / Chapter / Track Select
Skip Next / Skip Previous
Repeat (Chapter / Title / All) or (Track / All)
A-B Repeat
Shuffle
Enhanced ease of use graphical interface
Zoom (x1.33, x2, x4) with picture enhancement
3D Sound
Audio and video bit rate indicator

DVD FUNCTIONALITY

Multi-angle Selection
Audio Selection (1 out of max. 8 languages)
Subtitles Selection (1 out of max. 32 languages)
Aspect Ratio conversion (16:9, 4:3 Letterbox, 4:3 Pan Scan)
Parental Control and Disc Lock
Disc Menu support (Title Menu and Root Menu)
Resume (5 discs) after stop / standby
Screen Saver (Dim 75% after 15 min.)
Programming Titles/chapters with Favorite Selection

VIDEO CD FUNCTIONALITY

Playback Control for VCD 2.0 discs
Parental Control and Disc lock
Resume (5 discs) after stop / standby
Screen Saver (Dim 75% after 15 min.)
Programming Tracks with Favorite Selection

AUDIO CD FUNCTIONALITY

Time Display (Total / Track / Remaining Track Time)
Full audio functionality with remote control
Programming with Favorite Track Selection

LASER

Type :	Semiconductor laser Ga AlAs
Wave length :	650 nm (DVD) 780 nm (VCD/CD)
Output Power :	7 mW (DVD) 10 mW (VCD/CD)
Beam divergence :	60 degree

* typical playing time for movie with 2 spoken languages and 3 subtitle languages.

** equivalent to 500 lines on your TV

Specifications subject to change without prior notice



YAMAHA ELECTRONICS CORPORATION, USA 6660 ORANGETHORPE AVE., BUENA PARK, CALIF. 90620, U.S.A.
YAMAHA CANADA MUSIC LTD. 135 MILNER AVE., SCARBOROUGH, ONTARIO M1S 3R1, CANADA
YAMAHA ELECTRONIK EUROPA G.m.b.H. SIEMENSSTR. 22-34, 25462 RELINGEN BEI HAMBURG, F.R. OF GERMANY
YAMAHA ELECTRONIQUE FRANCE S.A. RUE AMBROISE CROIZAT BP70 CROISSY-BEAUBOURG 77312 MARNE-LA-VALLEE CEDEX02, FRANCE
YAMAHA ELECTRONICS (UK) LTD. YAMAHA HOUSE, 200 RICKMANSWORTH ROAD WATFORD, HERTS WD1 7JS, ENGLAND
YAMAHA SCANDINAVIA A.B. J A WETTERGRENS GATA 1, BOX 30053, 400 43 VÄSTRA FRÖLUNDA, SWEDEN
YAMAHA MUSIC AUSTRALIA PTY, LTD. 17-33 MARKET ST., SOUTH MELBOURNE, 3205 VIC., AUSTRALIA

YAMAHA CORPORATION
3139 246 10573 Printed in China